

***LEFT HAND** HOG SHOWN. FLYWHEEL AND FANWHEEL ARE ON THE **LEFT** WHEN LOOKING AT THE HOG FROM THE FRONT.

THE **BACK** OF THE HOG IS THE SIDE WITH THE PIVOTING DOOR

SHAFT EXTENSION GUARD COVER ON SIDE OPPOSITE DRIVE

THE **FRONT** OF THE HOG IS THE SIDE WITH THE ANVILS

 2017 Thelma Street | PO Box 3687
 Jacksonville, Florida 32206 USA
 Phone: (904) 355-5671 | Fax: (904) 355-0401
 www.montgomeryindustries.com

EQUIPMENT:		HD-HZF-BH	
MATERIAL LIST:		23-03.24	PAGE 1 OF 5

DETAIL VIEW - ANVIL RACK

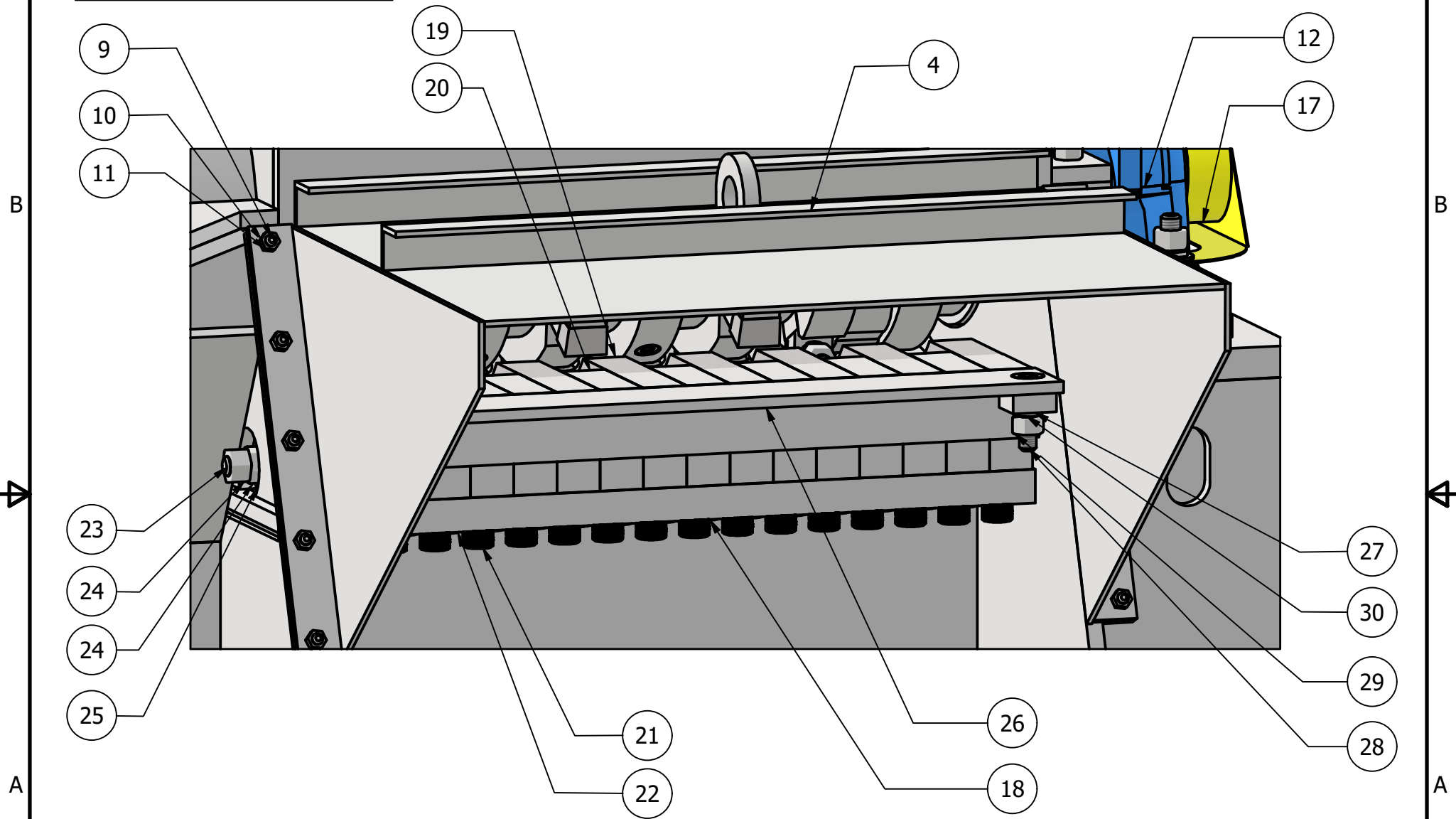

	2017 Thelma Street PO Box 3687 Jacksonville, Florida 32206 USA Phone: (904) 355-5671 Fax: (904) 355-0401 www.montgomeryindustries.com		EQUIPMENT:	HD-HZF-BH
	MATERIAL LIST:	23-03.24	PAGE 2 OF 5	

DETAIL VIEW - ROTOR

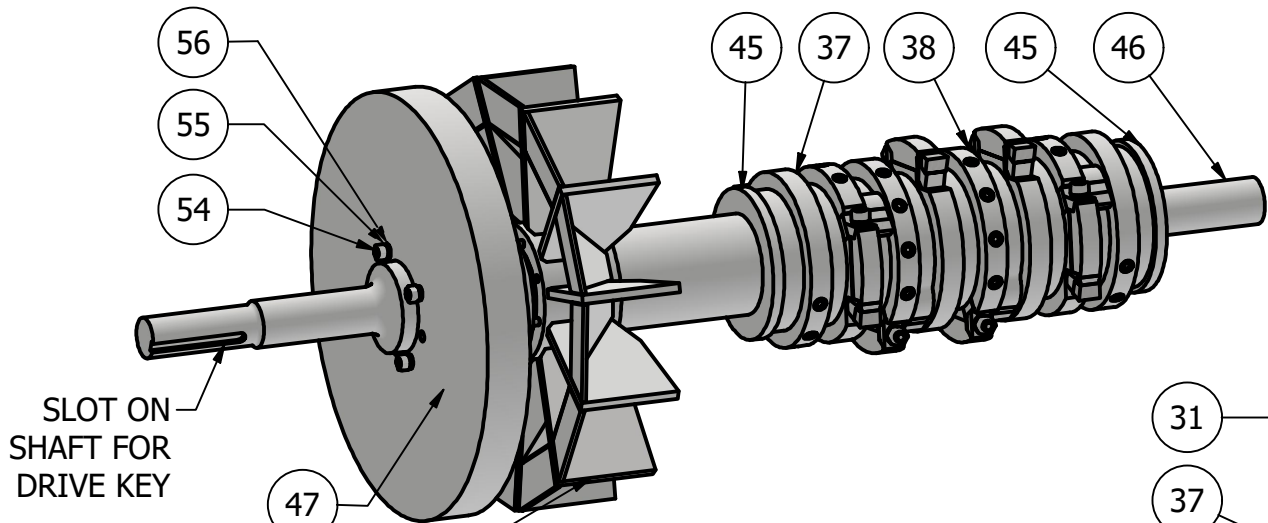

SLOT ON SHAFT FOR DRIVE KEY

*LEFT HAND HOG SHOWN. RIGHT HAND HOG HAS FLYWHEEL & FANWHEEL ON RIGHT SIDE.

*STANDARD T3 TOOTH SHOWN. 2-PART T3 TEETH HAVE A SCREW-IN SHANK INSTEAD OF THE HEX NUT.

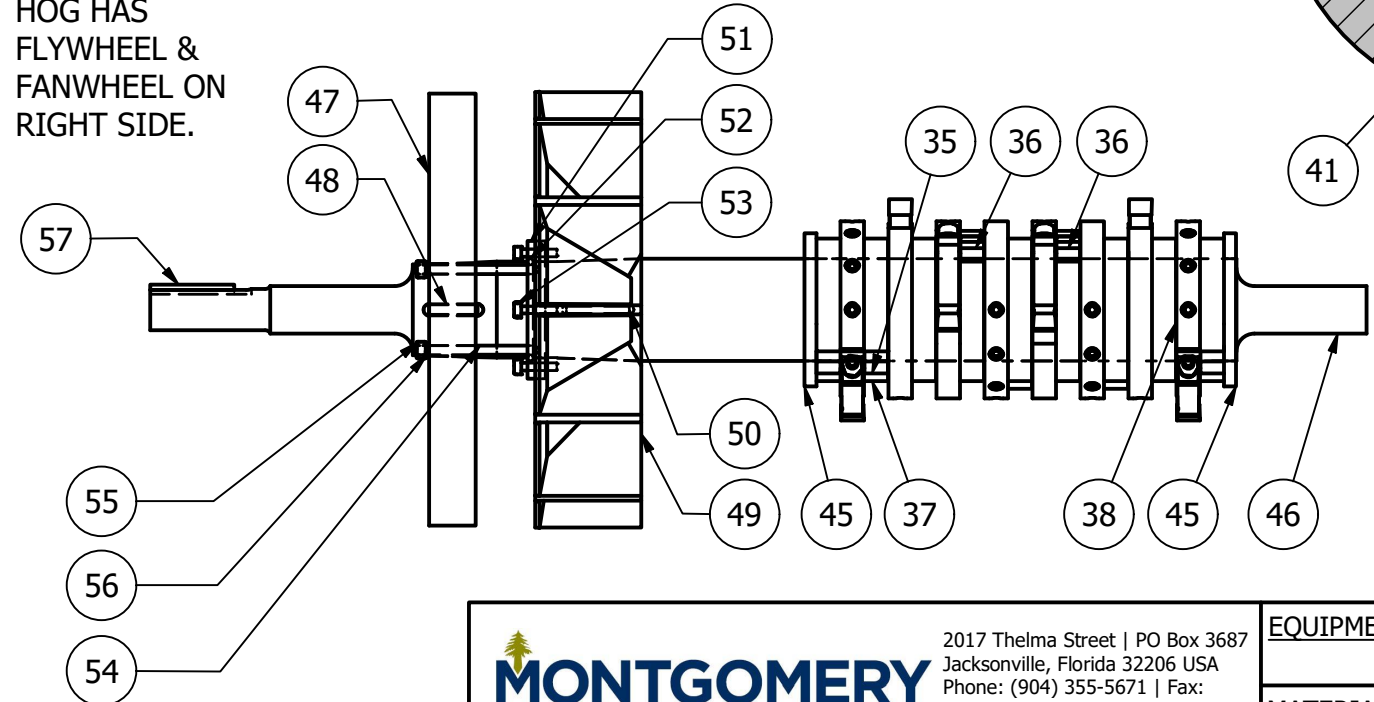
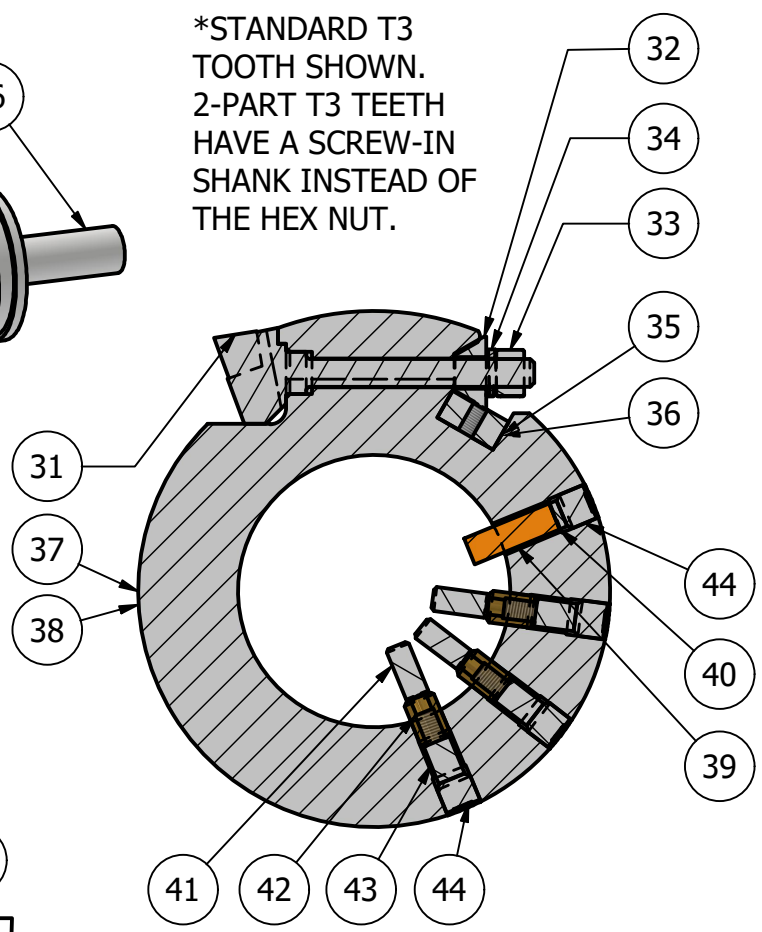

*ALL T3 CUT HOGS HAVE (1) 6" RING WITH (1) 1-1/2" X 6" INSIDE TOOTH. REMAINING RINGS ARE 4" RINGS WITH 1-1/2" X 4" INSIDE TEETH.

 2017 Thelma Street | PO Box 3687
 Jacksonville, Florida 32206 USA
 Phone: (904) 355-5671 | Fax: (904) 355-0401
 www.montgomeryindustries.com

EQUIPMENT:		HD-HZF-BH	
MATERIAL LIST:		23-03.24	PAGE 3 OF 5

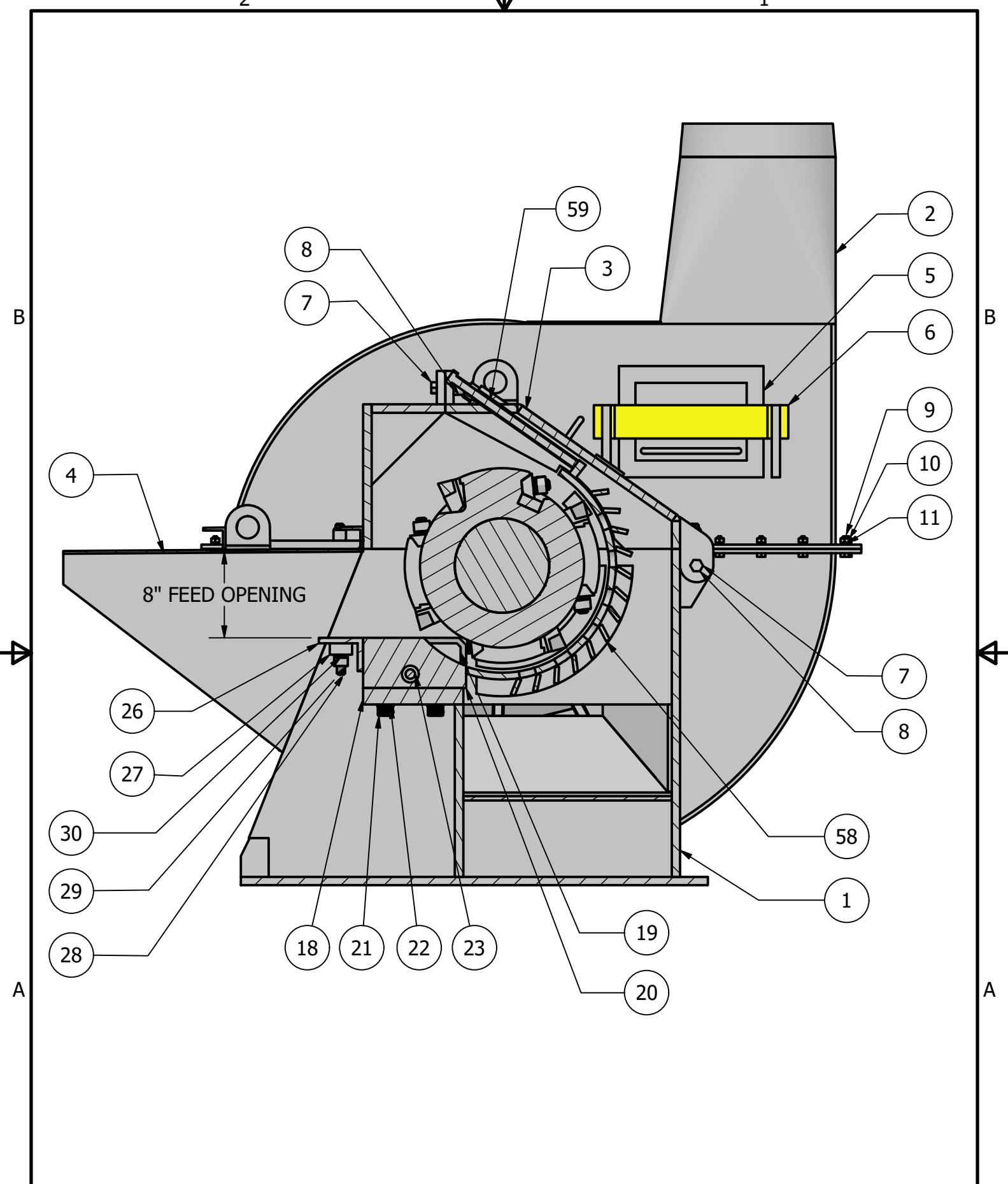

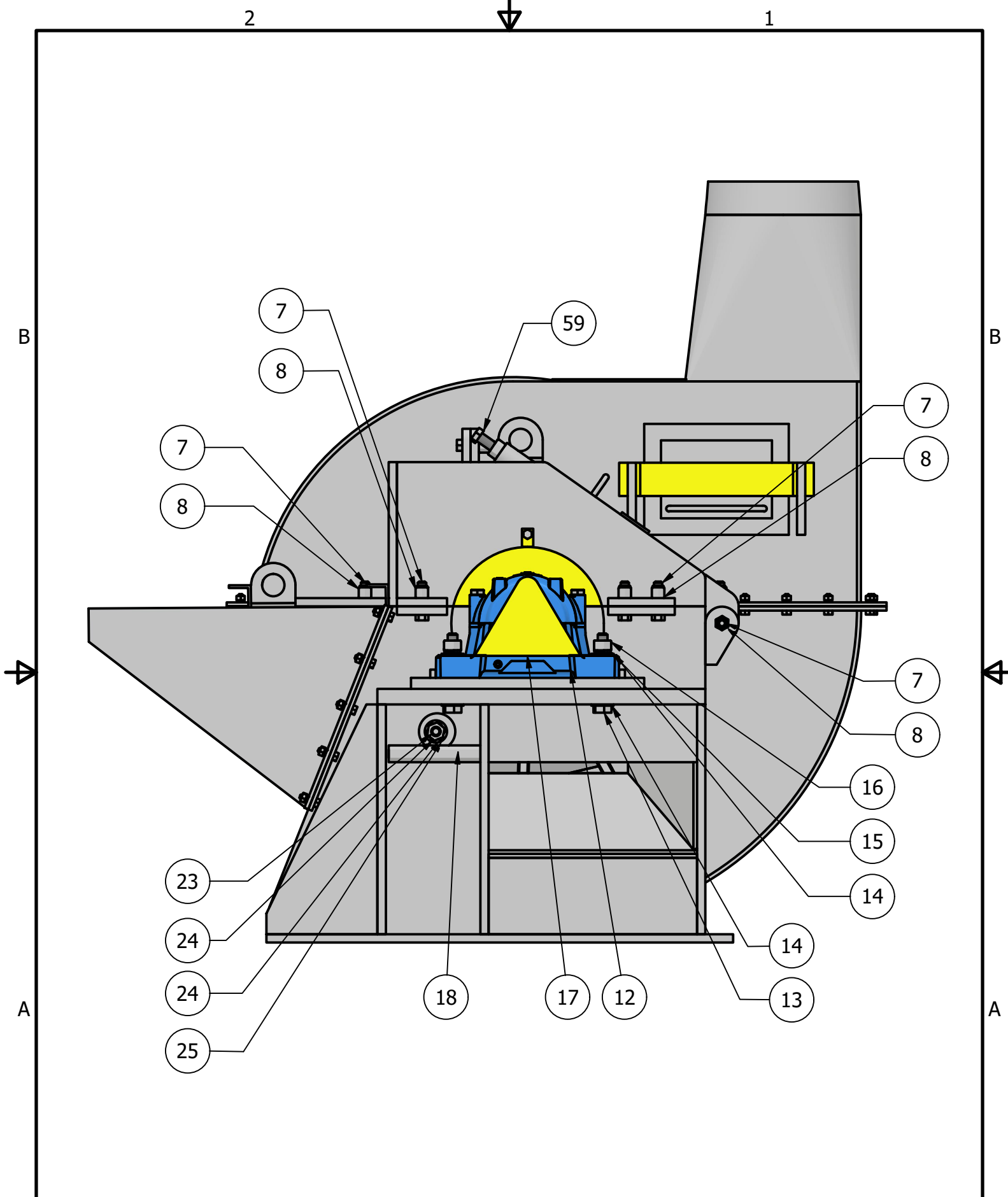



MONTGOMERY INDUSTRIES INTERNATIONAL

Phone: 904-355-5671 | Fax: 904-355-0401

2017 Thelma Street PO Box 3687

Jacksonville, Florida 32206

MATERIAL LIST 23-03.24



Refer to Serial Number and Order by Part Number and Description





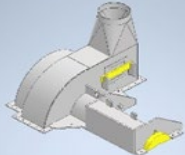
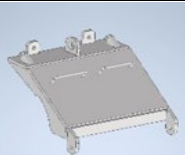
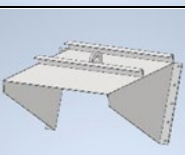

CUSTOMER:

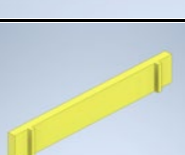
GENERIC PARTS LIST - REFERENCE THE PARTS LIST FOR YOUR SERIAL NUMBER FOR MACHINE-SPECIFIC INFORMATION AND PART QUANTITIES

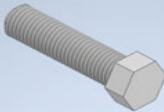
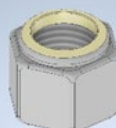
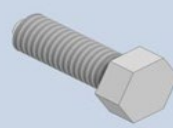
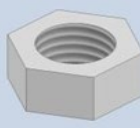
REFERENCE	QTY	PART NUMBER	DESCRIPTION	THUMBNAIL	NOTES
-----------	-----	-------------	-------------	-----------	-------

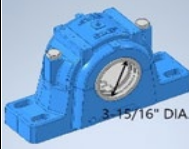
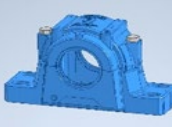

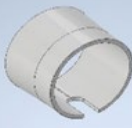
HOG HOUSING



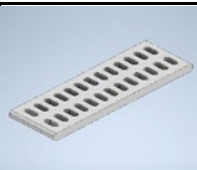
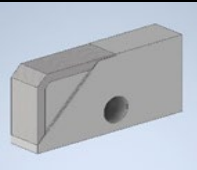
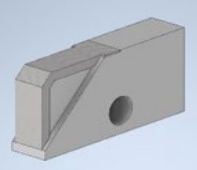

1	1	367-07218 367-13891	HD-HZF-BH Lower Housing		Part number dependent upon hog size, fan size, & blowpipe size
2	1	367-14567 367-14689	HD-HZF-BH Upper Housing		Part number dependent upon hog size, fan size, & blowpipe size
3	1	363-05848	HD-HZF Rear Door		
4	1	368-05850	Feed Chute for Horizontal Hogs		
5	1	363-06394	Inspection Door		Located on intake side of fan upper housing
6	1	363-06392	Locking Bar for Inspection Door		Located on intake side of fan upper housing

7	VARIES	151-07509	3/4" X 3" Hex Head Cap Screw		(2) - Secures Rear Door to Lower Housing (Pivot Hinges)
					(Varies) - Secures Rear Door to Upper Housing (Varies) - Secures Upper Housing to Lower Housing
8	VARIES	152-07502-09	3/4" Nylon Insert Hex Nut		(2) - Secures Rear Door to Lower Housing (Pivot Hinges)
					(Varies) - Secures Rear Door to Upper Housing (Varies) - Secures Upper Housing to Lower Housing (Varies) - Secures Upper Housing to Lower Housing around Fan
9	VARIES	151-05005	1/2" X 1-1/2" Hex Head Cap Screw		(10) - Secure Feed Chute to Lower Housing
					(Varies) - Secures Upper Housing to Lower Housing around Fan
10	VARIES	152-05001	1/2" Hex Nut		(10) - Secure Feed Chute to Lower Housing
					(Varies) - Secures Upper Housing to Lower Housing around Fan
11	VARIES	153-05002	1/2" Lock Washer		(Varies) - Secures Upper Housing to Lower Housing around Fan
					(10) - Secure Feed Chute to Lower Housing
12	2	181-39301 181-44301	Bearing (Complete)		Typically 3-15/16" or 4-7/16"; Consists of 12a - 12e
12a	2	181-39302 181-44302	Pillow Block Housing		
12b	2	181-39303 181-44303	Bearing Unit		
12c	2	181-39304 181-44304	Adapter Assembly		Tapered adapter keeps bearing in correct position on shaft
12d	4	181-39305 181-44305	Oil Seal		Oil seals secure lubrication within bearing housing
12e	1	181-39306 181-44306	Stabilizing Ring		Only installed on Drive Side



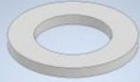
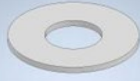

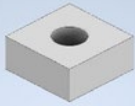

13	8	151-08816	7/8" X 6-1/2" Hex Head Cap Screw		Secures Bearings to Hog Housing
14	16	153-08801	7/8" Flat Washer		Secures Bearings to Hog Housing
15	8	153-08802	7/8" Lock Washer		Secures Bearings to Hog Housing
16	8	152-08802	7/8" 2H Hex Nut, Heavy		Secures Bearings to Hog Housing
17	1	299-14774	Shaft Extension Guard Cover for Blo-Hogs		Covers the exposed end of the Hog shaft opposite the drive side



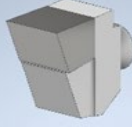

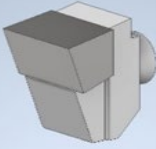
ANVIL RACK ASSEMBLY

18	1	308-05436	Anvil Plate for Horizontal Hogs		Welded into Hog Lower Housing
19	VARIES	302-05439	Large H Anvil		For use with Standard Cut T3 Teeth
19 (ALTERNATE)	VARIES	302-07157	Large H Cutaway Anvil		For use with Overlapping Cut T3 Teeth
20	VARIES	302-14285	Small H-3 Anvil		
21	VARIES	151-08833	7/8" X 3" Socket Head Cap Screw		(2) per Anvil - Secure Anvils to Anvil Plate

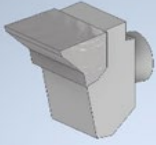
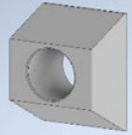
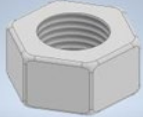

22	VARIABLES	153-08805	7/8" Flat Washer - SAE Alloy		(2) per Anvil - Secure Anvils to Anvil Plate
23	1	314-06001	Anvil Tie Rod		Runs through Anvils & squeezes them together when tightened
24	4	152-08801-02	7/8" 2H Hex Nut, Heavy		For Anvil Tie Rod
25	2	153-08801	7/8" Flat Washer		For Anvil Tie Rod
26	1	364-05849	HD-HZF Anvil Stop		Helps hold Anvils in position
27	2	364-10324	Anvil Stop Lug		For mounting Anvil Stop to Hog housing
28	2	151-07552	3/4" X 3" Flat Socket Head Cap Screw		For Anvil Stop
29	2	152-07501	3/4" Hex Nut, Heavy		For Anvil Stop
30	2	153-07502	3/4" Lock Washer		For Anvil Stop

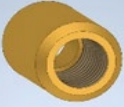

ROTOR

31	VARIES	301-03587	T3 Tooth, Standard Cut		For use with regular Anvils
31 (ALTERNATE)	VARIES	301-17297	T3 2-Part Tooth, Standard Cut		For use with regular Anvils
31 (ALTERNATE)	VARIES	301-03588	T3 Tooth, Overlapping Cut		For use with cutaway Anvils
31 (ALTERNATE)	VARIES	301-17298	T3 2-Part Tooth, Overlapping Cut		For use with cutaway Anvils
31 (ALTERNATE)	VARIES	301-14527	T3 Tooth, High Rake, Standard Cut		For use with regular Anvils
31 (ALTERNATE)	VARIES	301-17450	T3 2-Part Tooth, High Rake, Standard Cut		For use with regular Anvils
31 (ALTERNATE)	VARIES	301-14680	T3 Tooth, High Rake, Overlapping Cut		For use with cutaway Anvils
31 (ALTERNATE)	VARIES	301-17451	T3 2-Part Tooth, High Rake, Overlapping Cut		For use with cutaway Anvils
32	VARIES	310-03933	HD Wedge		Secures Inside Teeth Underneath T3 Teeth
33	VARIES	152-08801-02	7/8" 2H Hex Nut, Heavy		For T3 Tooth

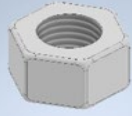
33 (ALTERNATE)	VARIABLES	151-08818	7/8" NC X 7" Hex Head Cap Screw, Grade 5		For T3 2-Part Tooth
34	VARIABLES	153-08802	7/8" Lock Washer		For T3 Tooth
35	1	301-03583	1-1/2" X 6" Inside Tooth		For 6" HD-GM Ring
36	VARIABLES	301-03582	1-1/2" X 4" Inside Tooth		For 4" HD-GM Rings
37	1	304-03554	6" HD-GM Ring		
38	VARIABLES	304-03555	4" HD-GM Ring		
39	VARIABLES	330-03930	Oil Cylinder - 1" Dia. X 2-9/16" Long		(1) Per Ring
40	VARIABLES	311-03935	Spacer - 7/8" X 1/4" (Oil Cylinder, HD-GM)		(1) Per Ring
41	VARIABLES	151-07565	3/4" NC X 1-3/4" Socket Set Screw		(3) Per Ring - Helps back out Shear Pins when they have been sheared
42	VARIABLES	154-03759-6	Bronze Shear Pin		(3) Per Ring
43	VARIABLES	311-03936	Spacer - 7/8" X 1-1/4" (Shear Pin, HD-GM)		(3) Per Ring

44	VARIABLES	151-11355	1-1/8" NF X 1" Socket Set Screw		(4) Per Ring
45	2	307-03023	End Flange for HD Hogs		Welded to outermost rings on Hog Rotor - provide location for balance weights
46	1	305-02002	HD & PM Blo-Hog Shaft		
47	1	306-04024 306-04025	Blo-Hog Flywheel		Flywheel size depends on hog size, fan size, & bearing size
48	1	329-03879	Key for Flywheel, 1" X 1" X 4"		Secures Flywheel to Hog Shaft
49	1	293-00040-09 293-00050-09	Blo-Hog Fanwheel		#40 and #50 fans most typical for HD-HZF-BH
50	1	329-03888	Key for Blo-Hog Fanwheel, 1/2" X 3/4" X 6"		Secures Fanwheel to Hog Shaft
51	1	307-03026	Blo-Hog Flywheel Retaining Flange		Helps secure Flywheel & Fanwheel
52	1	329-03027	Split Retaining Ring for HD & PM Blo-Hogs		For Flywheel Retaining Flange
53	4	151-06376	5/8" NC X 3" Square Head Set Screw		Tightens down Flywheel Retaining Ring to Fanwheel
54	4	314-07596 314-07598	Flywheel Stud		Secures Flywheel to Flywheel Retaining Ring; size depends on Flywheel size

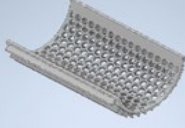
55	4	152-07501	3/4" Hex Nut, Heavy		Secures Flywheel to Flywheel Retaining Ring
56	4	153-07502	3/4" Lock Washer		Secures Flywheel to Flywheel Retaining Ring
57	1	329-03883 329-03878	Key for Connecting Drive Components to Hog Shaft		Dimensions depend on bearing size

SCREEN					
58	1	362-14286	HD-HZF Screen		Reordering criteria: -Hole size -Clearance (Standard/Non-standard) -Baffles/No baffles -Plate Thickness (Standard/Non-standard)
58 (ALTERNATE)	1	362-05829	Old Style HD-HZF Screen (Serial Numbers < 1912)		Reordering criteria: -Hole size -Clearance (Standard/Non-standard) -Baffles/No baffles -Plate Thickness (Standard/Non-standard)
59	VARIABLES	362-14608	HD-HZF & FS-HZF Screen Hold Down Bolt		Runs through Rear Door & tightens down Screen; 10" Hogs have (1) Screen Hold Down Bolt. All other sizes have (2).