

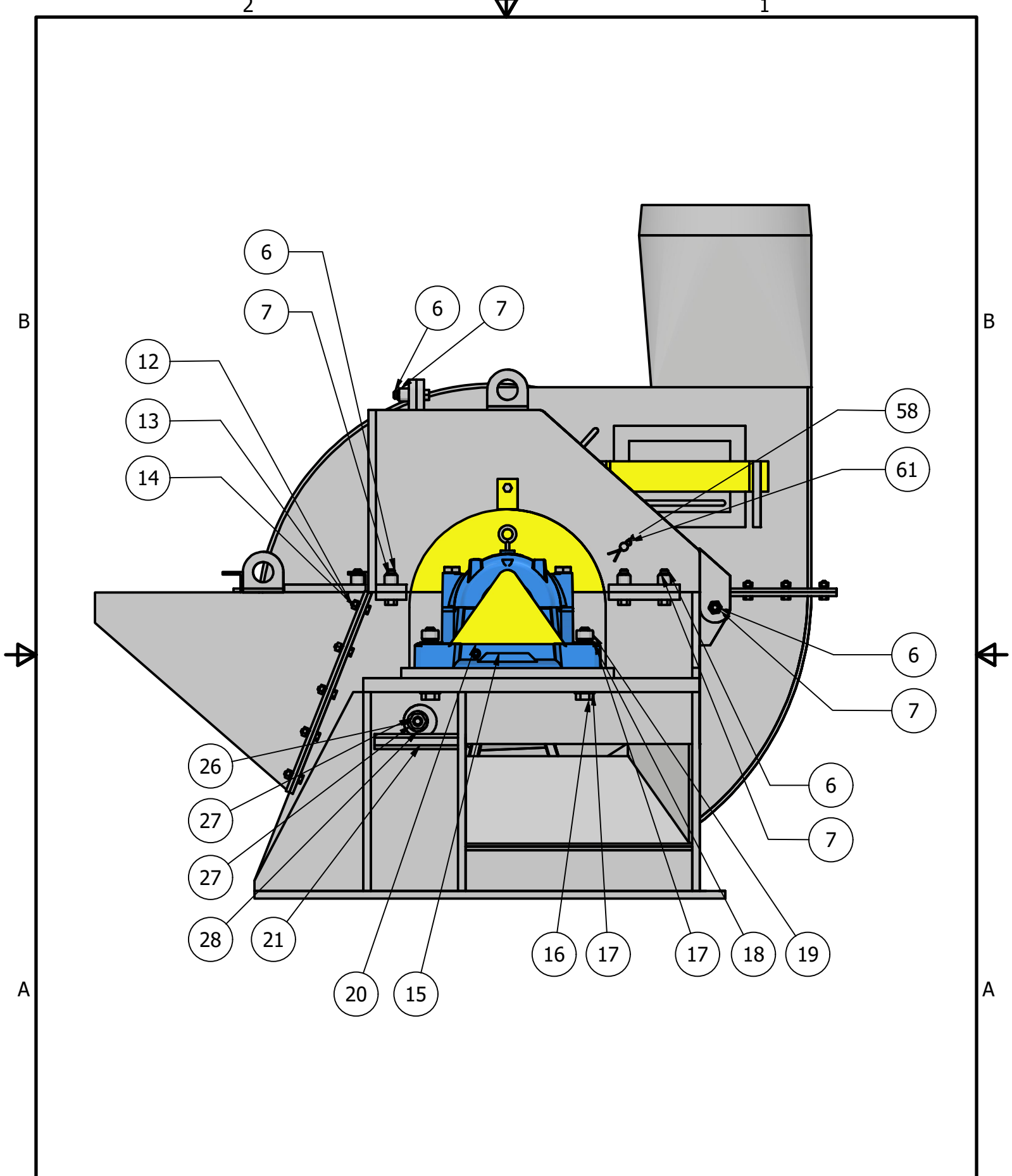

MONTGOMERY
 INDUSTRIES INTERNATIONAL

2017 Thelma Street | PO Box 3687
 Jacksonville, Florida 32206 USA
 Phone: (904) 355-5671 | Fax:
 (904) 355-0401
www.montgomeryindustries.com

<u>EQUIPMENT:</u>	PM-HZF-BH	
<u>MATERIAL LIST:</u>	23-38.23	PAGE 1 OF 5



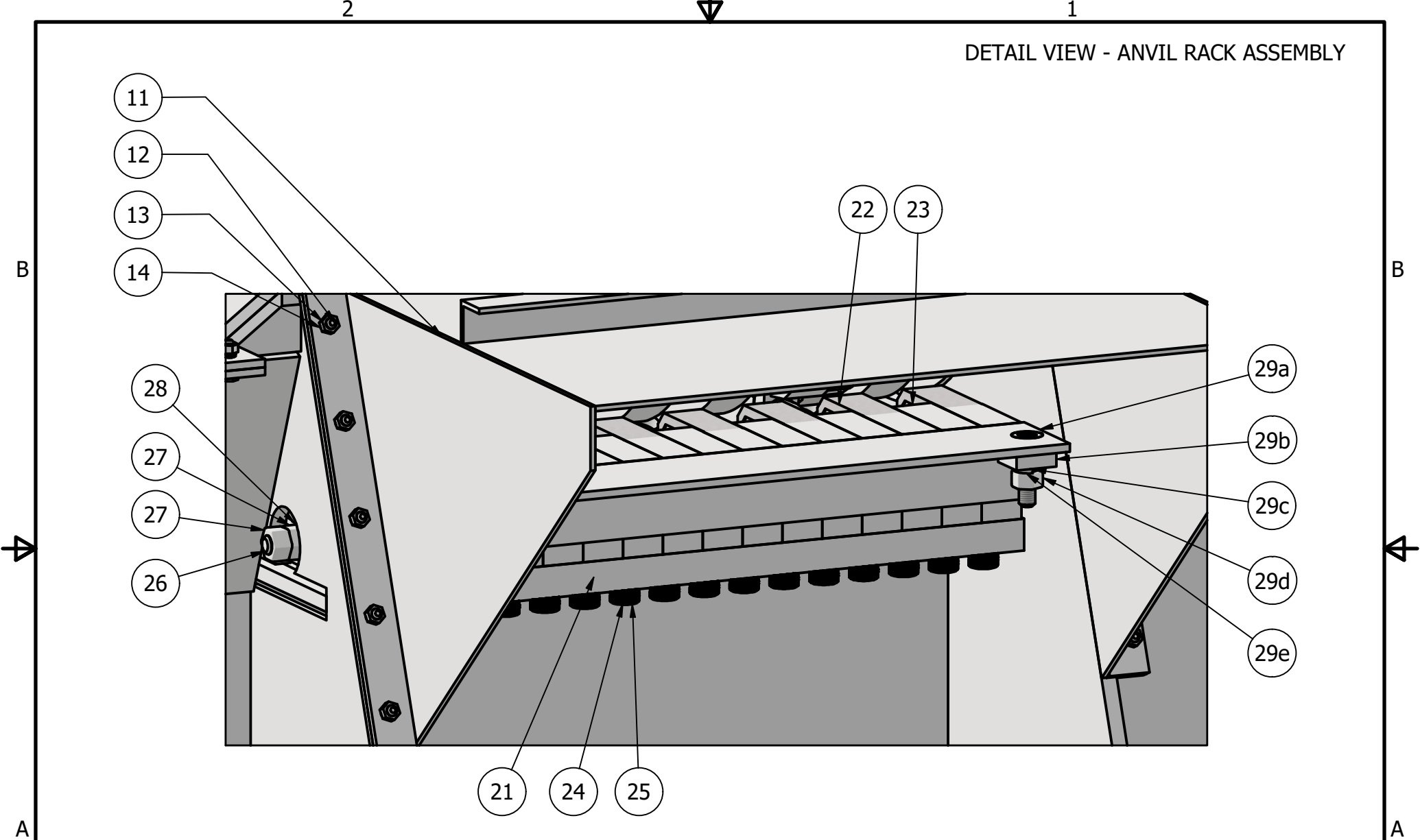

DETAIL VIEW - ANVIL RACK ASSEMBLY

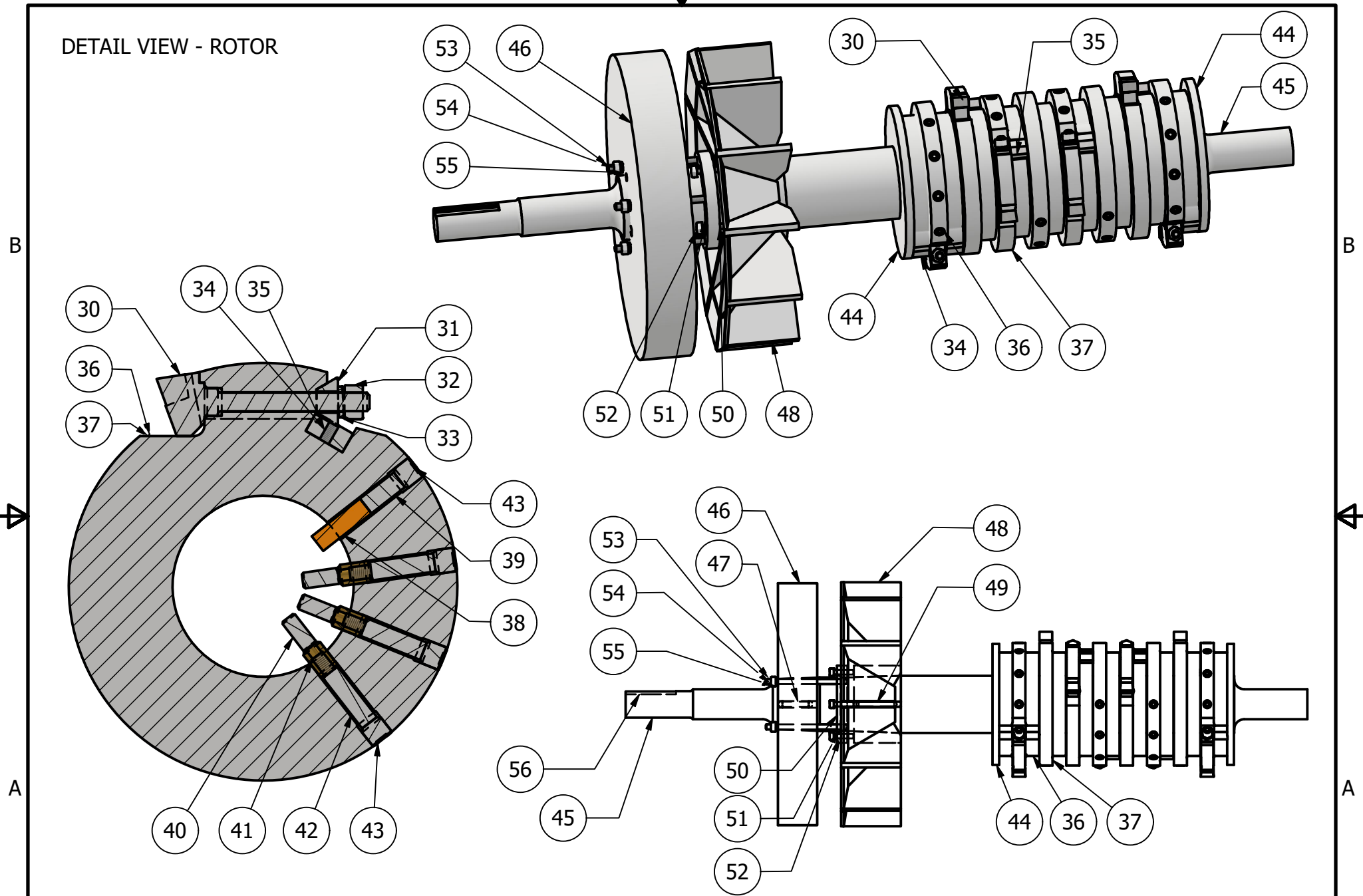

	2017 Thelma Street PO Box 3687 Jacksonville, Florida 32206 USA Phone: (904) 355-5671 Fax: (904) 355-0401 www.montgomeryindustries.com	EQUIPMENT: PM-HZF-BH
	MATERIAL LIST: 23-38.23	PAGE 2 OF 5

DETAIL VIEW - ROTOR



	2017 Thelma Street PO Box 3687 Jacksonville, Florida 32206 USA Phone: (904) 355-5671 Fax: (904) 355-0401 www.montgomeryindustries.com		EQUIPMENT:	PM-HZF-BH
			MATERIAL LIST:	23-38.23

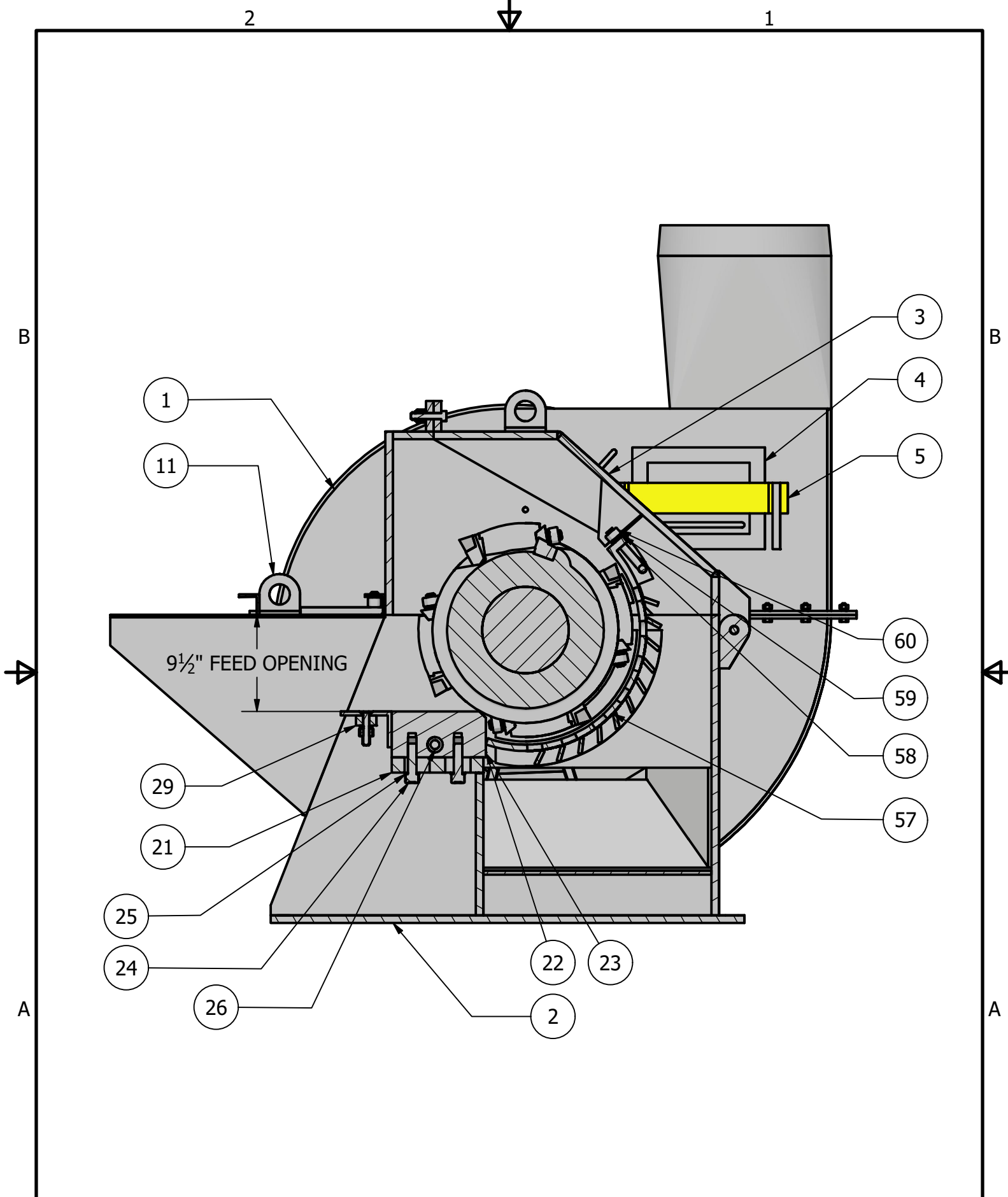



MONTGOMERY INDUSTRIES INTERNATIONAL

Phone: 904-355-5671 | Fax: 904-355-0401

2017 Thelma Street PO Box 3687

Jacksonville, Florida 32206

MATERIAL LIST 23-38.23

Refer to Serial Number and Order by Part Number and Description







CUSTOMER:

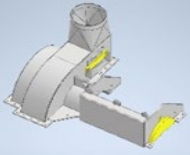
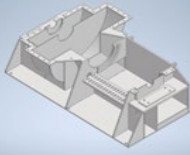
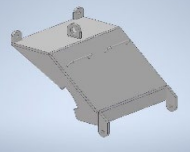
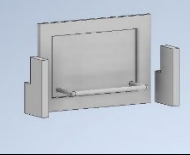
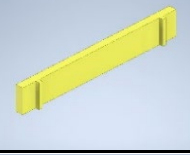
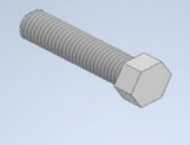

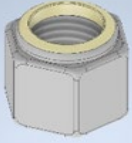
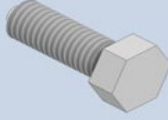
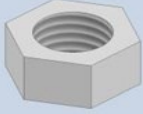

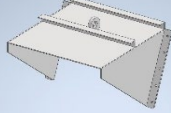
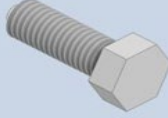
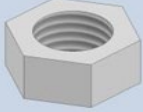

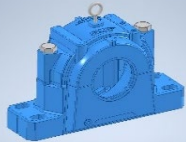

GENERIC PARTS LIST - REFERENCE THE PARTS LIST FOR YOUR SERIAL NUMBER FOR MACHINE-SPECIFIC INFORMATION AND PART QUANTITIES

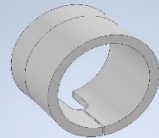
REFERENCE	QTY	PART NUMBER	DESCRIPTION	THUMBNAIL	NOTES
-----------	-----	-------------	-------------	-----------	-------

HOG HOUSING

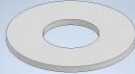

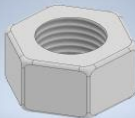



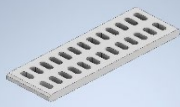
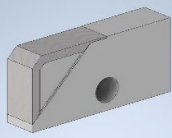

1	1	367-10543 267-14812 367-14813	PM-HZF-BH Upper Housing		Part number dependent upon hog size, fan size, & blowpipe size
2	1	367-09392 367-14810 367-14811	PM-HZF-BH Lower Housing		Part number dependent upon hog size, fan size, & blowpipe size
3	1	363-09029	PM-HZF Rear Door		
4	1	363-06394	Inspection Door		Loaded on intake side of Fan Upper Housing
5	1	363-06392	Locking Bar for Inspection Door		Located on intake side of Fan Upper Housing
6	9	151-07509	3/4" X 3" Hex Head Cap Screw		(3) - Secures Side Housing
					(2) - Hog to Fan Transition
					(2) - Rear Door Pivot
					(2) - Rear Door Locking Ears

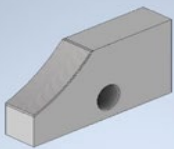
7	9	152-07502-09	3/4" Nylon Insert Hex Nut		(3) - Secures Side Housing
					(2) - Hog to Fan Transition
					(2) - Rear Door Pivot
					(2) - Rear Door Locking Ears
8	VARIABLES	151-05005	1/2" X 1-1/2" Hex Head Cap Screw		Secures Upper Housing of Fan to Lower Housing of Fan
9	VARIABLES	152-05001	1/2" Hex Nut		Secures Upper Housing of Fan to Lower Housing of Fan
10	VARIABLES	153-05003	1/2" Lock Washer		Secures Upper Housing of Fan to Lower Housing of Fan
11	1	368-05850	Feed Chute for Horizontal Hogs		Dimensions dependent on fan size & hog size
12	10	151-05005	1/2" X 1-1/2" Hex Head Cap Screw		Secures Feed Chute to Hog Housing
13	10	152-05001	1/2" Hex Nut		Secures Feed Chute to Hog Housing
14	10	153-05002	1/2" Lock Washer		Secures Feed Chute to Hog Housing
15	2	181-44301 181-54301	Bearing (Complete)		Typically 4-7/16" or 5-7/16"; Consists of 15a - 15e
15a	2	181-44302 181-54302	Pillowblock Housing		
15b	2	181-44303 181-54303	Bearing Unit		

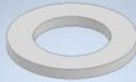

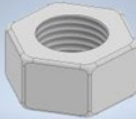
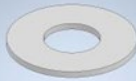

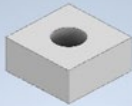

15c	2	181-44304 181-54304	Adapter Assembly		Tapered adapter keeps bearing in correct position on shaft
15d	4	181-44305 181-54305	Oil Seal		Oil seals secure lubrication within bearing housing
15e	1	181-44306 181-54306	Stabilizing Ring		Only installed on the Drive Side
16	8	151-08816 151-10016	Hex Head Cap Screw		Secures Bearings to Hog Housing
17	16	153-08801 153-10001	Flat Washer		Secures Bearings to Hog Housing
18	8	153-08802 153-10002	Lock Washer		Secures Bearings to Hog Housing
19	8	152-08801 152-10001	2H Hex Nut, Heavy		Secures Bearings to Hog Housing
20	1	299-14774	Shaft Extension Guard Cover for Blo-Hogs		Covers the exposed end of the Hog shaft opposite the Drive Side

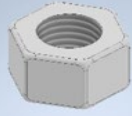
ANVIL RACK ASSEMBLY

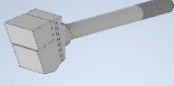
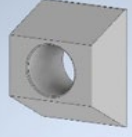
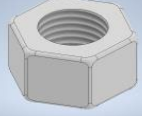
21	1	308-05436	Anvil Plate for HZF Hogs		
22	VARIES	302-05439	Large H Anvil		Line up with Inside Teeth on Rotor

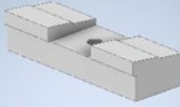
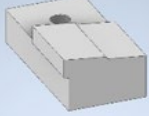

23	VARIABLES	302-14285	Small H3 Anvil, Long		Line up with T3 Teeth on Rotor
24	VARIABLES	151-08833	7/8" X 3" Socket Head Cap Screw		(2) Per Anvil - secures Anvils to Anvil Plate
25	VARIABLES	153-08805	7/8" Flat Washer - SAE Alloy		(2) Per Anvil - secures Anvils to Anvil Plate
26	1	314-06001	Anvil Tie Rod		Runs through Anvils & squeezes them together when tightened
27	4	152-08801-02	7/8" 2H Hex Nut, Heavy		For Anvil Tie Rod
28	2	153-08801	7/8" Flat Washer		For Anvil Tie Rod
29	1	364-10325	PM-HZF Anvil Stop Assembly		Consists of 29a - 29e
29a	1	364-10325	HZF Anvil Stop		
29b	2	316-10324	Anvil Stop Lug		Welded to Hog Housing
29c	2	151-07552	3/4" X 3" Flat Head Socket Cap Screw		Secures Anvil Stop to Anvil Stop Lug
29d	2	153-07502	3/4" Lock Washer		Secures Anvil Stop to Anvil Stop Lug

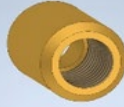

29e	2	152-07501	3/4" Hex Nut, Heavy		Secures Anvil Stop to Anvil Stop Lug
-----	---	-----------	---------------------	---	--------------------------------------

ROTOR					
30	VARIABLES	301-03587	T3 Tooth, Standard Cut		
31	VARIABLES	310-03933	HD Wedge		Secures Inside Teeth Underneath T3 Teeth
32	VARIABLES	152-08801-02	7/8" 2H Hex Nut, Heavy		For T3 Tooth
33	VARIABLES	153-08802	7/8" Lock Washer		For T3 Tooth
34	1	301-03583	1-1/2" X 6" Inside Tooth		For 6" PM-GM Ring
35	VARIABLES	301-03582	1-1/2" X 4" Inside Tooth		For 4" PM-GM Rings
36	1	304-03558	6" PM-GM Ring		
37	VARIABLES	304-03559	4" PM-GM Ring		
38	VARIABLES	330-03930	Oil Cylinder - 1" Dia. X 2-9/16" Long		(1) Per Ring

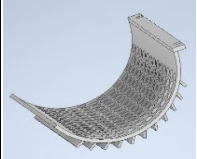
39	VARIABLES	311-03941	Spacer - 7/8" X 2" (Oil Cylinder, PM-GM)		(1) Per Ring
40	VARIABLES	151-07565	3/4" NC X 1-3/4" Socket Set Screw		(3) Per Ring - Helps back out Shear Pins when they have been sheared
41	VARIABLES	154-03759-6	Bronze Shear Pin		(3) Per Ring
42	VARIABLES	311-03943	Spacer - 7/8" X 3" (Shear Pin, PM-GM)		(3) Per Ring
43	VARIABLES	151-11355	1-1/8" NF X 1" Socket Set Screw		(4) Per Ring
44	2	307-04530	End Flange for PM Hogs		Welded to outermost rings on Hog Rotor - provide location for balance weights
45	1	305-02002	Blo-Hog Shaft, HD & PM		
46	1	306-04025	6 X 36 BH Flywheel		
47	1	329-03879	Key for Flywheel, 1" X 1" X 4"		Secures Flywheel to Hog Shaft
48	1	293-00040-09 293-00050-09 293-00060-09	Blo-Hog Fanwheel		
49	1	329-03888	Key for Blo-Hog Fanwheel, 1/2" X 3/4" X 6"		Secures Fanwheel to Hog Shaft

50	1	307-03026	Blo-Hog Flywheel Retaining Flange		
51	1	329-03027	Split Retaining Ring for HD & PM Blo-Hogs		
52	4	151-06376	5/8" NC X 3" Square Head Set Screw		Tightens down Flywheel Retaining Ring to Fanwheel
53	4	314-07598	Flywheel Stud, 3/4" X 12" (6 X 36 Flywheel)		Secures Flywheel to Flywheel Retaining Ring
54	4	152-07501	3/4" Hex Nut, Heavy		Secures Flywheel to Flywheel Retaining Ring
55	4	153-07502	3/4" Lock Washer		Secures Flywheel to Flywheel Retaining Ring
56	1	329-03878	Key for Shaft, 1" X 1" X 7"		Connects Hog Shaft to Direct-Drive Motor

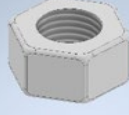
SCREEN					
57	1	362-14484	Screen for PM-HZF Hog		Hole Size
					Clearance - Standard/Non-standard
					Baffles/No Baffles
					Plate Thickness - Standard/Non-standard
58	2	362-14485	PM-HZF Screen Hold Down Bolt		Clamps the back end of the Screen in place

59	2	153-07502	3/4" Lock Washer		Tightens Screen Hold Down Bolts
60	2	152-07501	3/4" Hex Nut, Heavy		Tightens Screen Hold Down Bolts
61	2	154-01879	3/16" X 2" Steel Cotter Pin		Secures Screen Hold Down Bolts to Hog Housing