

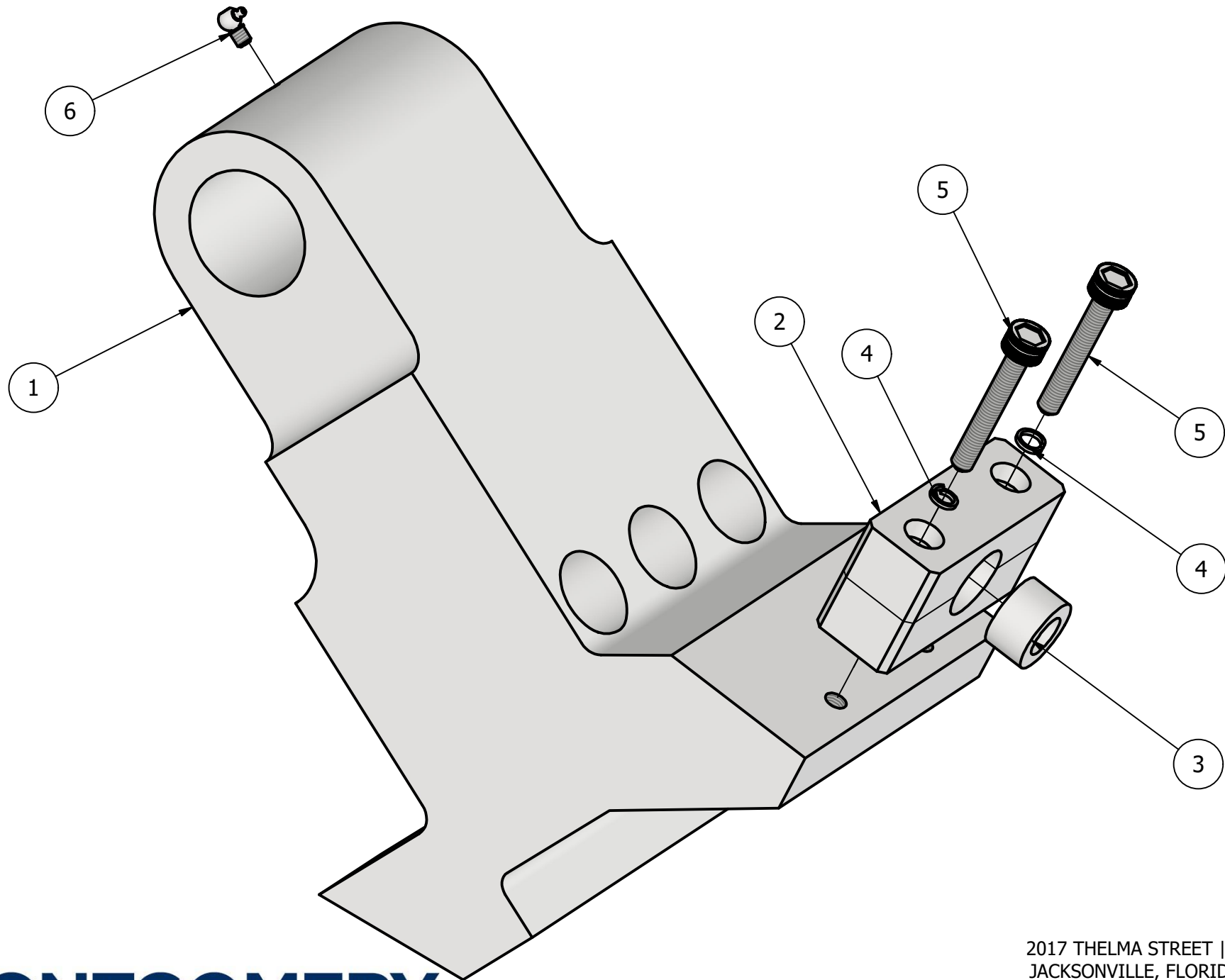





9" CS-KC ANVIL HOLDER ASSEMBLY

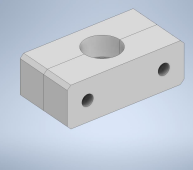

9" CS-KC Anvil Holder Assembly Parts List				
Item	Part Number	Thumbnail	QTY	Description
1	303-13066		1	9" Anvil Holder with 1" Bushings for CS-KC Hogs
2	317-13092		1	CS-KC Split Bushing Block
3	155-03889-2		1	Hardened Steel Bushing
4	153-05002		2	1/2" Lock Washer
5	151-05041		2	1/2" x 3.5" Socket Head Cap Screw
6	196-16138		1	#1613-B 1/8" 90 Degree Grease Fitting